

User manual resistance thermometer Type WTR 270...

Safety instructions !!!

intended use of the product

- The sensor has been designed exclusively for the intended use described here or in the datasheet and may only be used in this way.
- The technical specifications contained in these operating instructions must be observed.
- Improper handling or operation of the device outside of its technical specifications requires the device to be taken out of service immediately and an inspection by promesstec.
- When the device is transported from a cold into a warm environment, the formation of condensation may result in the device malfunctioning.
- Before putting it back into operation, wait for the device temperature and the room temperature to equalise.

The manufacturer shall not be liable for claims of any type based on operation contrary to the intended use!!

staff qualification

Improper handling can result in considerable personal injury and damage to equipment. The activities described in these operating instructions may only be carried out by skilled staff who have the appropriate qualifications. For installation and starting of the sensor, the relevant regulations and directives of the country and the norms must be observed. Especially during installation of the sensor, it is possible, depending on the use, to come into contact with aggressive media. The safety instructions must be observed. There will be danger to life if live parts are touched. Electrical installation and commissioning may only be carried out by qualified and skilled personnel.

special hazards

Residual media in and on dismantled devices can result in a risk to personnel, the environment and equipment. Sufficient precautionary measures must be taken here. Do not use the instruments in safety or emergency stop devices. Incorrect application or operation of the instrument can lead to injuries. Depending on the application, aggressive media with extreme temperatures and high pressure or vacuum may be present at the instrument in the event of a fault. We recommend installing and removing the device only at ambient temperature and in a pressureless mode.

hazards when operating the device

Our devices have a very high protection class when properly mounted and installed. When cleaning your system with high-pressure cleaners, steam cleaners etc., make sure that both the cover and the cable screw or the connector are not directly exposed to the pressure jet. If the temperature falls below the dew point, condensation may form in the connection chamber of the device. In such extreme applications, contact our sales and technical support before commissioning.

temperature measurement

dimensions WTR 270...

WTR 270... (example illustration)

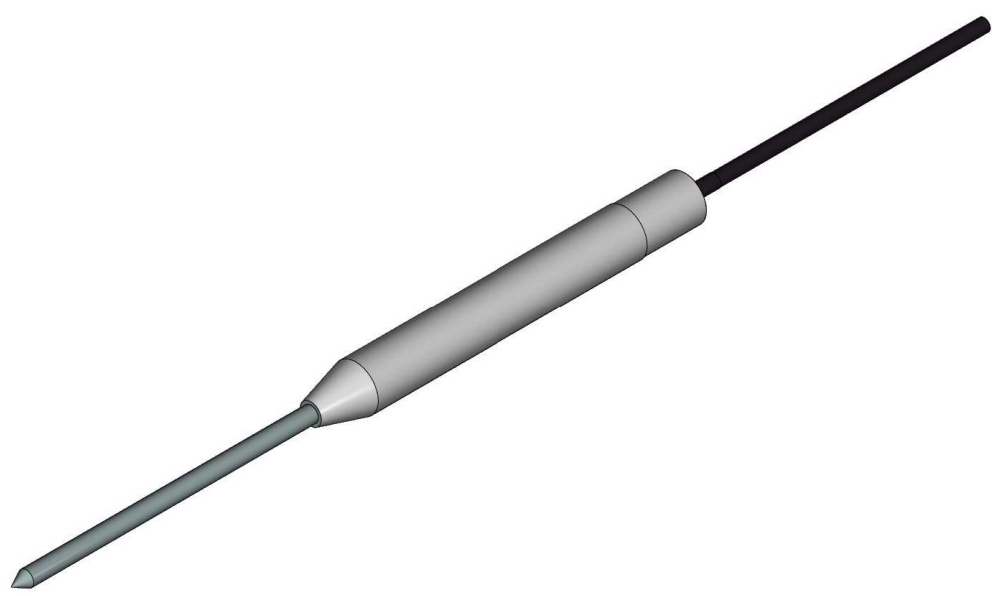
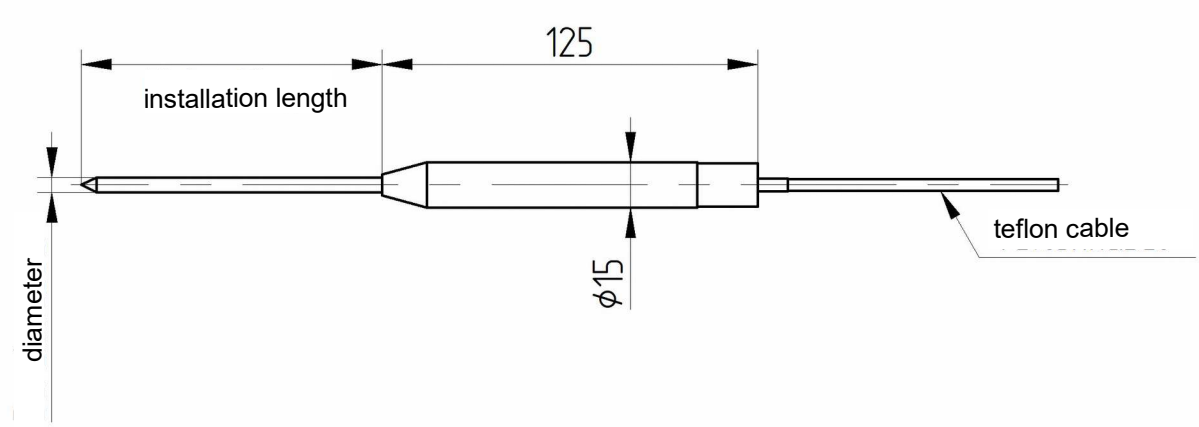

temperature measurement

connection WTR 270 (core identification)

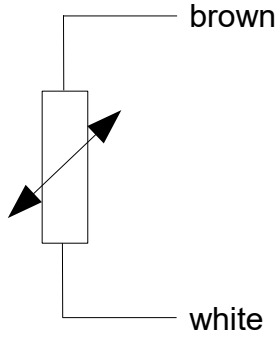
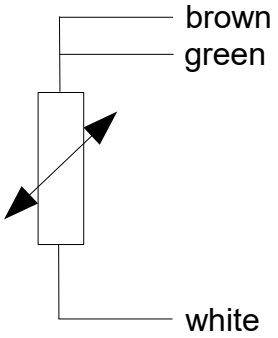
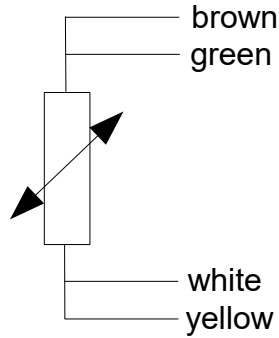
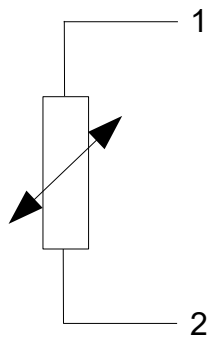
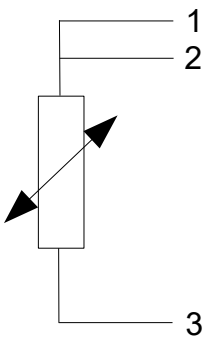
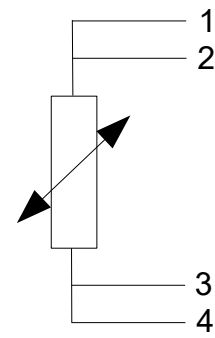
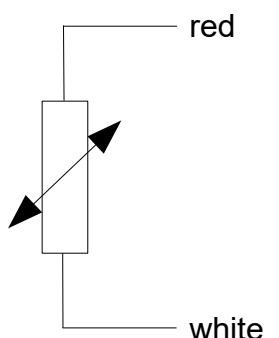
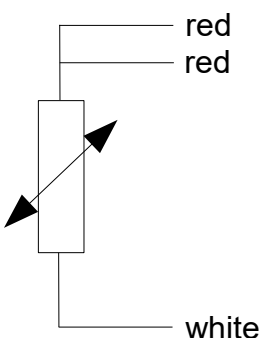
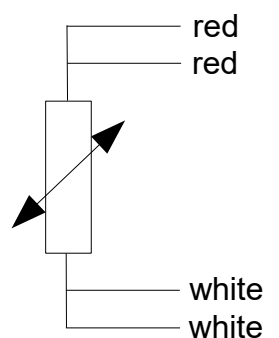
cable material	2-wire connection	3-wire connection	4-wire connection
PVC			
PUR			
silicone teflon GGVA			

Attention !!:

Pay attention to the maximum temperature range of the connecting cable.

PVC : cable material PVC, temperature range standard max. +85°C

PUR : cable material PUR, temperature range standard max. +105°C

silicone: cable material silicone, temperature range standard max. +180°C

teflon : cable material teflon, temperature range standard max. +260°C

GGVA: cable material glass fiber with VA sheath, temperature range standard max. +400°C

temperature measurement

Mounting instructions !!!

mechanical installation

- Only use promesstec welding sleeves and process connections for the adaptation in your process. Only by this we can guarantee you an optimal measuring point.
- After installing the sensor, check the tightness of the measuring point.
- When laying the cable, pay attention to the maximum permissible temperature range of the cable.

electrical mounting

- Install the sensor in your process before electrical installation. In this way you avoid winding up the cable when installing the measuring point.
- The electrical installation must be carried out in a voltage-free state.
- Connect your sensor to your evaluation electronics in accordance with the specified circuit.

Important information !!!

return and repair

The promesstec sensor have a modular design. This allows us to repair and overhaul defective devices. To do this, send the device to promesstec. You will find a return form with the information to be provided on our homepage under „technical information“.

disposal of the devices

Dispose of devices, components and packaging in an environmentally friendly manner in accordance with the waste treatment and disposal regulations typical for the country. Pay attention to waste separation and the recycling of high-quality materials such as stainless steel, etc.

further documentation

You can find these quick start guide and the data sheets as a file on our homepage under the respective devices. The documentation is available in German and in English. Other languages on request. Additional information such as characteristic curves of temperature sensors etc. can be found on our homepage at

