

## **short manual digital display UDA 50-...-A & -B**

### **safety instructions !!!**

#### intended use of the product

- The UDA 50 has been designed exclusively for the intended use described here or in the data sheet and may only be used in this way.
- The technical specifications contained in these operating instructions must be observed.
- Improper handling or operation of the device outside of its technical specifications requires the device to be taken out of service immediately and an inspection by promesstec.
- When the device is transported from a cold into a warm environment, the formation of condensation may result in the device malfunctioning.
- Before putting it back into operation, wait for the device temperature and the room temperature to equalise.

*The manufacturer shall not be liable for claims of any type based on operation contrary to the intended use!!*

#### staff qualification

Improper handling of the UDA 50 can result in considerable personal injury and damage to the equipment. The activities described in these user manual may only be carried out by skilled staff who have the appropriate qualifications. For installation and starting of the UDA 50, the relevant regulations and directives of the country and the norms must be observed. The safety instructions must be observed. There will be danger to life if live parts are touched. Electrical installation and commissioning may only be carried out by qualified and skilled personnel.

#### special hazards

Do not use the UDA 50 in safety or emergency stop devices. Incorrect application or operation of the device can lead to injuries. When cleaning the UDA 50, do not use chemicals, volatile solvents such as thinners or strong cleaning agents. It can result in deformation of the housing as well as lead to an impairment of the operation. Use only a soft cleaning towel.

#### hazards when operating the device

When cleaning your unit with high-pressure cleaners, steam cleaners, etc. make sure that the UDA 50 does not come into contact with moisture. If the temperature falls below the dew point, condensation may form in the connection chamber of the device. In such extreme applications, contact our sales and technical support before commissioning.

## evaluation devices

### overview UDA 50-...-A & -B

### features

The UDA 50 is a 4 digit LED digital display for front panel mounting. In different configurations it is used for measuring voltage/current or temperature sensor PT100 2 or 3-wire. The configuration is done via the 3 front buttons. With a protection class of IP65 at the front, it can also be used in rough industrial applications.

### overview representation

protection class front side IP65

removable clamps



operating buttons

4-digit LED display

### dimensions

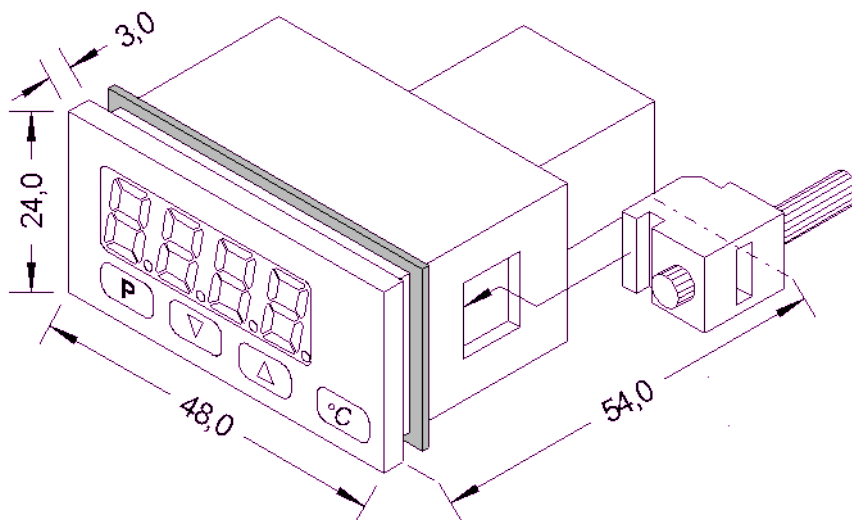

Installation cutout 45,0+0.8mm x 22,2+0.6 mm

# evaluation devices

## electrical connection UDA 50-...-A & -B

### terminal assignments

**power supply version UDA 50-2...**

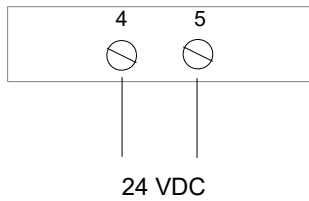

**power supply version UDA 50-3...**

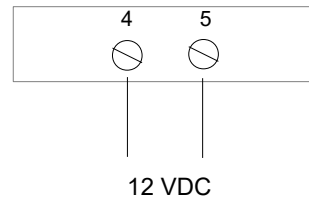

**measuring input version UDA 50-...-A...**

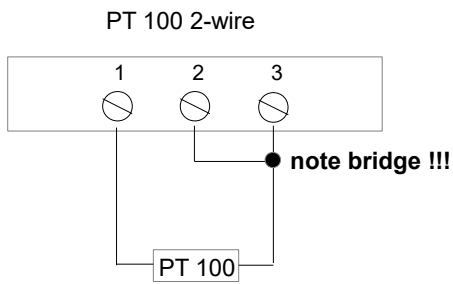

**measuring input version UDA 50-...-A...**

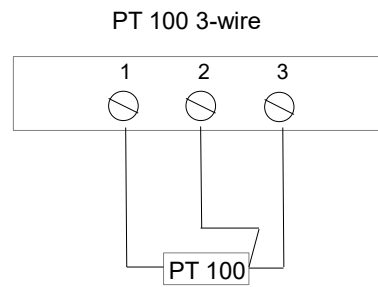

**measuring input version UDA 50-...-B...**

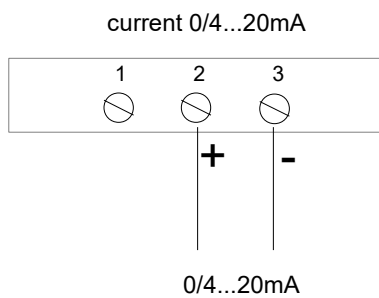

**measuring input version UDA 50-...-B...**

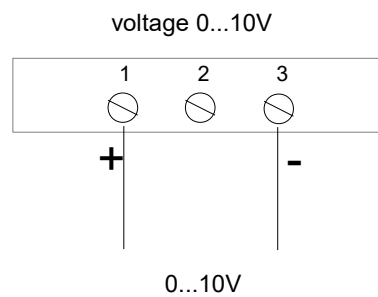

Further connection diagrams and the complete user manual can be found on our homepage.

## evaluation devices

### mounting instructions !!!

#### mechanical installation

- The UDA 50 is not designed for potentially explosive area. There is risk of explosion.
- The UDA 50 is designed for front installation in a switch cabinet or a closed housing. The dimensions of a suitable section can be found in the user manual. When making the section, make sure that the UDA 50 is not mechanically braced during installation.
- When mounting the UDA 50 in the front panel of the switch cabinet, make sure that the housing is not strained by the fastening elements. It can result in an impairment of the function.
- When selecting the installation location, make sure that the UDA 50 is kept away from shock, vibration and electromagnetic fields, such as frequency converters, motors and from transformers.

#### electrical mounting

- all electrical work is to be carried out only in a de-energized state.
- the supply current circuit must be protected by a suitable protective device, the fuse should be selected as low as possible.
- keep signal and supply voltage lines separate from each other. If this is not possible, use shielded cables for signal wiring.

### important information !!!

#### return and repair

The promesstec sensors have a modular design. This allows us to repair and overhaul defective devices. To do this, send the device to promesstec. You will find a return form with the information to be provided on our homepage under „technical information“.

#### disposal of the devices

Dispose of devices, components and packaging in an environmentally friendly manner in accordance with the waste treatment and disposal regulations typical for the country. Pay attention to waste separation and the recycling of high-quality materials such as stainless steel, etc.

#### further documentation

You can find this short manual, the data sheets and a complete manual as a file on our homepage under the respective devices. The documentation is available in German as well as in English. Other languages on request.

