

User manual

Flow sensor CFS 200



version 2.1.1

Inhalt

1. General.....	3
1.1 Description	3
1.2 Symbols and abbreviations	3
2. Transport, packaging and storage	4
2.1 Transport.....	4
2.2 Packaging.....	4
2.3 Storage.....	4
3. Safety instructions	4
3.1 Intended use of the product.....	4
3.2 Personnel qualification	5
3.3 Special hazards	5
4. Starting, operation	6
4.1 Process connection	6
4.2 Outdoor conditions	6
4.3 Interference sources.....	6
4.4 Vibration	7
4.5 Vibration	7
4.6 Correct installation position	7
4.7 Installation	8
4.8 Electrical installation	8
4.8.1 Electrical connection	8
4.8.2 Schalt-/Öffnungskontakte.....	9
4.9 Output 4...20mA.....	10
4.10 Starting up	11
5. Adaptation and control.....	12
6. Technical data	13
7. Dimensions.....	14
7.1 Accessories	15
8. Dismounting, Return, Cleaning, Disposal	15
8.1 Dismounting	15
8.2 Return.....	15
8.3 Cleaning	16
8.4 Disposal.....	16

Flow sensor CFS 200

1. General

1.1 Description

The flow sensor CFS 200 is designed for liquids and is based on the calorimetric measuring principle, according to which the flow rate of the measured liquid is proportional to the function of heat transfer from the sensor to the surroundings. Prompt and simple installation and lower costs thanks to its simple construction are the principal advantages.

The sensors are not restricted by the electrical conductivity of the liquid. Owing to the calorimetric measuring principle used, the measurement is dependent on thermal conductivity of the liquid. The meter can reach its highest sensitivity within the range of 4 ÷ 150 cm/s for use with water. For other liquids with different thermal conductivity, the measuring range is different. The measuring range can be modified by user to a certain extent, whereas it holds true that the lower thermal conductivity of medium, the higher flow rates can be measured.

1.2 Symbols and abbreviations



Warning!

A non-observance can cause injuries to persons and/or the demolition of the device. There can be a dangerous to life.



Attention!

A non-observance can cause a faulty operation of the device or lead to property damage.



Info!

A non-observance can have influence on the operation of the device or cause unintentional reactions of the device.



Danger!

Should the safety instructions not be observed, there is a risk of serious or fatal injury caused by electrical power.



Warning!

Possibly a dangerous situation can occur, which results in burns because of hot surfaces or liquids, if not avoided.

2. Transport, packaging and storage

2.1 Transport

Check the instrument for any damage that may have been caused during transportation. If, report them immediately. The temperature during transportation and storage of the meter must be within the range of -10 °C up to 80°C.

2.2 Packaging

Do not remove packaging until just before mounting. Keep the packaging as it will provide optimum protection during transport (e.g. change in installation site, sending back).

2.3 Storage

For longer term storage avoid the following influences:

1. Direct sunlight or proximity to hot objects
2. Mechanical vibration, mechanical shock (putting it hard down)
3. Soot, vapor, dust and corrosive gases

If possible store the device in original package or an equivalent one.

The temperature during transportation and storage of the meter must be within the range of -10 °C up to 80°C.

3. Safety instructions



More important safety instructions can be found in the individual chapters.

3.1 Intended use of the product

The sensor has been designed and built solely for the intended use described here and may only be used accordingly. The technical specifications contained in these operating instructions must be observed. Improper handling or operation of the instrument outside of technical specifications requires the instrument to be taken out of service immediately and an inspection by the manufacturer. When the instrument is transported from a cold into a warm environment, the formation of condensation may result in the instrument malfunctioning. Before putting it back into operation, wait for the instrument temperature and the room temperature to

equalize. The manufacturer shall not be liable for claims of any type based on operation contrary to the intended use.

3.2 Personnel qualification



Improper handling can result in considerable injury and damage to equipment.

- The activities described in these operating instructions may only be carried out by skilled personnel who have the qualifications described below.
- Keep unqualified personnel away from hazardous areas.

For installation and starting of the temperature sensor the personnel has to be familiar with the relevant regulations and directives of the country and must have the qualification required. They must have knowledge on measurement and control technology, have to be acquainted with electric circuits, are capable of carrying out the work described and can independently recognize potential hazards. Depending on the operation conditions of the application they have to have the corresponding knowledge, e.g. of aggressive media.

3.3 Special hazards



For hazardous media such as oxygen, acetylene, flammable or toxic gases or liquids, refrigeration plants, compressors, etc., in addition to all standard regulations, the appropriate existing codes or regulations must also be followed.

If you do not observe the appropriate regulation, serious injuries and/or damage can occur!



A protection from electrostatic discharge (ESD) is required. The proper use of grounded work surfaces and personal wrist straps is required when working with exposed circuitry (PCB, printed circuit boards), in order to prevent static discharge from damaging sensitive electronic components.



There is a danger of death caused by electric current. Upon contact with life parts, there is a direct danger of death. Electrical instruments may only be installed and connected by skilled electrical personnel. Operation using a defective power supply unit (e.g. short circuit from the mains voltage to the voltage output) can result in life-threatening voltages at the instrument.



Residual media in dismantled instruments can result in a risk to personnel, the environment and equipment. Take sufficient precautionary measures. Do not use this instrument in safety or Emergency Stop devices. Incorrect use of the instrument can result in injury. Should a failure occur, aggressive media with extremely high temperature and under high pressure or vacuum may be present at the instrument.

4. Starting, operation

4.1 Process connection

The flow meter monitor is usually delivered with a stainless steel sleeve nut M16x1.5 and with installed stainless steel cutting ring in the position that allows maximum insertion of the sensor into piping. After installation of the stainless steel cutting ring onto the sensor, it is not possible to change the depth of insertion of the sensor into piping; it is only possible when the PTFE ring is used special order necessary.

The accessories to the flow sensor may include various necks (adapters) serving for process installation and M12 (4-pin) connectors for electrical connection.

4.2 Outdoor conditions

It is necessary to prevent the flow sensor from being directly exposed to weather conditions and prevent the liquid to be measured from freezing over inside the flow sensor, which might damage the measuring tube.

In the case that the unit is located outdoors, promesstec recommends a protective case, and if appropriate, a roof to avoid direct sunshine so that the evaluation electronics cannot warm up excessively.

4.3 Interference sources

The most frequent interference sources affecting the stable flow of liquid are as follows:

- Pumps and bends or elbows located closely one after another in various planes. These elements should be found at least at a distance of $20xd$ (where d is the inside diameter of the meter in millimeters) before the flow sensor.
- The flow of liquid in the flow detector should be settled and free of whirls. Minimal recommended distances are $5xd$ before and $3xd$ after sensor.
- Abrupt variations of pipe cross-section if not made as a cone with an angle of $\alpha \leq 10^\circ$ (where α is the angle made by beveled walls of the pipe adapter).
- Whatever interfering in the flow of liquid, e.g. thermometer well.

- When a mixture of substances is made (or mixture of the same liquids with different temperatures) you need to install the flow meter either before the mixing location or at a sufficient distance after it (min.30xd), otherwise the indication may be unstable
- Branch lines, T-pieces, bends, elbows, slide valves, taps, flaps. Shut-off valves, control valves, butterfly valves and non-return valves. Pipe outputs from reservoirs, exchangers and filters.

4.4 Vibration

The scope and level of vibrations must be below 2.2 g in the range of 20 ÷ 50Hz frequencies according to IEC 068-2-34 standard.

4.5 Vibration

The scope and level of vibrations must be below 2.2 g in the range of 20 ÷ 50Hz frequencies according to IEC 068-2-34 standard.

4.6 Correct installation position

The flow detector (sensor), particularly its tip must be fully immersed (see Fig. a). For this reason, we do not recommend installing in the highest point of piping that may become aerated, or in sloping or even in horizontal piping with the open end into which air may penetrate, but conversely, in rising piping (see Fig. b).

Furthermore, the distance of the sensor tip from piping should be more than 11mm (see Fig. c).

During long-lasting measurements of very low flow rates ($Q < 0.1$ m/s), impurities may be deposited. In this case, carry out installation at horizontal piping sideways (see Fig. d).

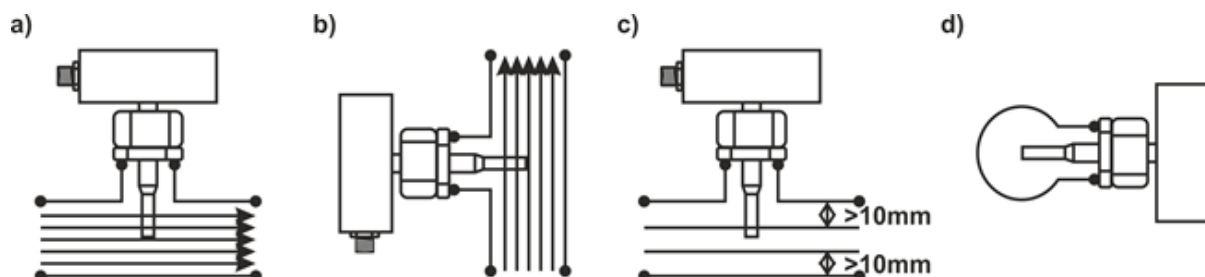

4.7 Installation

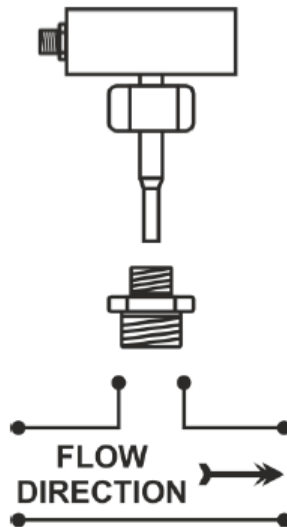

Before mounting is started, make sure that the system is depressurized or discharged. After that, install a suitable adapter to a T-piece or in some case in a welded-on piece or right on the pipe wall with adequate thread sealing. Then install the flow monitor in the adapter. In case of the stainless steel cutting ring, the length of insertion of the sensor in the adapter is given by the assembly of the built-in ring and cannot be changed. The length of insertion of the sensor can only be changed when using a ring made of PTFE. Tighten the stainless steel ring sleeve nut with the torque of 70Nm max. (in case of PTFE ring, 50Nm max).

When installed in piping and for the most precise flow evaluation, adhere to the orientation of the unit so that the M12 connector for electrical connection can form an upstream edge. So the medium should run from the same side where this connector is found.

4.8 Electrical installation



Always carry out any handling operations or installation of the device after disconnection of the supply voltage!!!

When the below mentioned operations are carried out unprofessionally, the claim to warranty become null and void!!!

4.8.1 Electrical connection

M12 connector wiring (compact version):



The flow monitor is equipped with a standard M12x1 connector with 4 pins.

The pin connection corresponds to the type of outputs and is shown on the tag plate of sensor.

CFS 200 – PNP

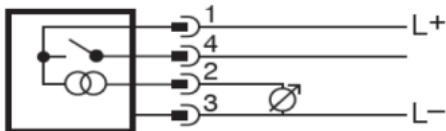

Standard switch contact connection:

PIN 1 – supply voltage +24V

PIN 2 – output 4...20mA

PIN 3 – supply voltage GND

PIN 4 – PNP-contact switch point

CFS 200 – NPN

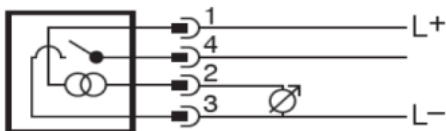

PIN 1 – supply voltage +24V

PIN 2 – output 4...20mA

PIN 3 – supply voltage GND

PIN 4 – NPN- contact switch point

4.8.2 Schalt-/Öffnungskontakte

The manufacturer delivers the meter with the switching point set as a contact maker unit. If the flow rate on compact version is above switching point, relay contact on pin 2 and pin 4 is closed (eventually is closed PNP/NPN contact on pin 4). If the flow rate is below switching point, relay contact is open. In case of separate version for DIN rail and with relay output when the flow is above switching point are pin 5 and 6 closed (eventually is closed PNP/NPN contact on pin 5 according to the wiring)

The function of contact maker/breaker can be changed by user to inverted logic if needed.

The typical response time is 1 ÷ 6sec and it is influenced by the rate of change of flow:

- The change of flow moves close to the switching point – slower response.
- The change of flow jumps over the switching point – quick response

The designation of a switching point on the LED scale can be implemented in two colours that indicate simultaneously if the switching contact is closed or open:

- Red LED – open contact
- Amber LED – closed contact

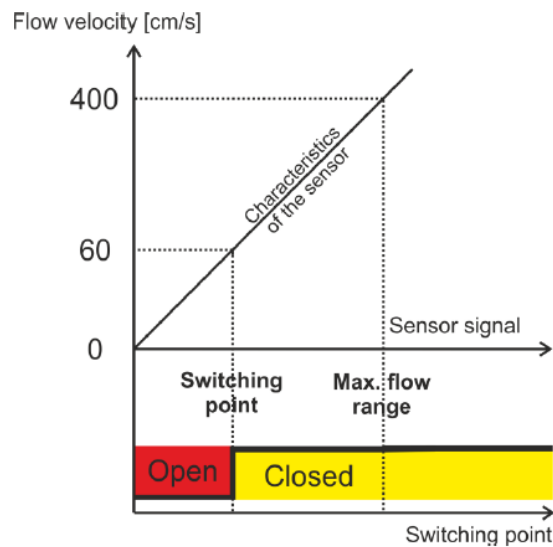

4.9 Output 4...20mA

The factory setting of CFS 200 is delivered with the output 4 -20 mA, that at zero flow velocity output value is 4 mA and at 4 m / sis output value 20 mA. The dependence of the power on speed of flow is not linear.

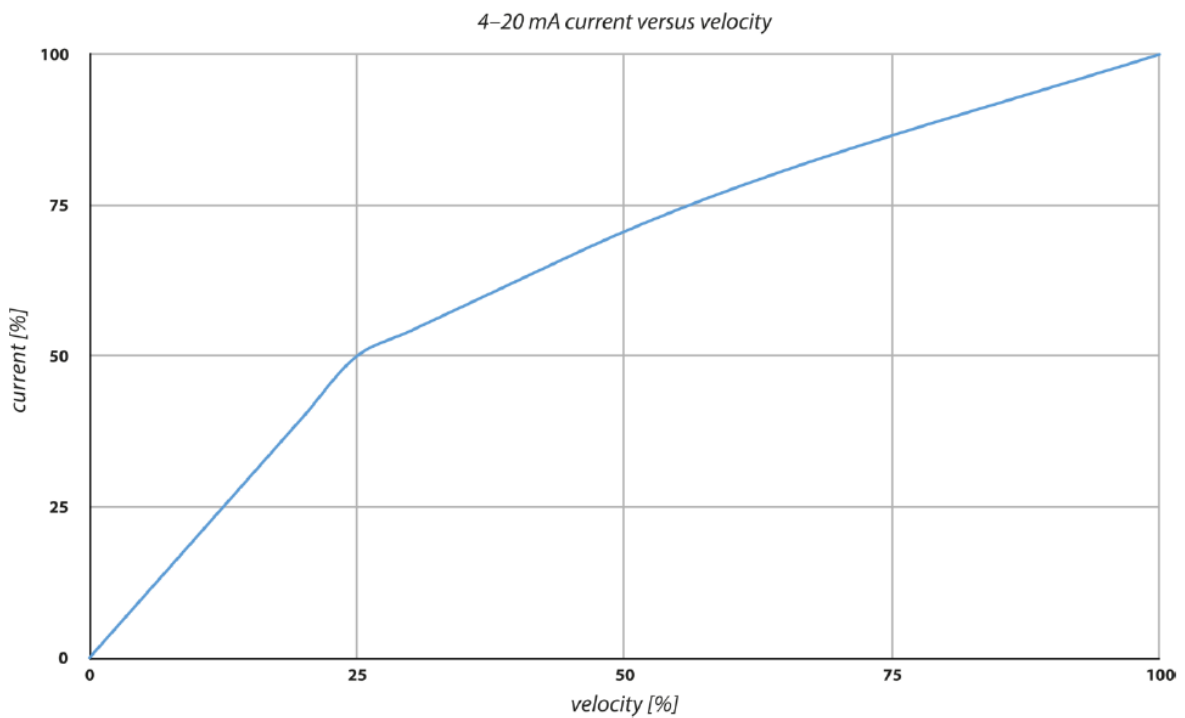

4.10 Starting up

After powering the flow switch make a self-test and self-diagnostics LED, then goes fluently to the measuring mode.

Compact version:

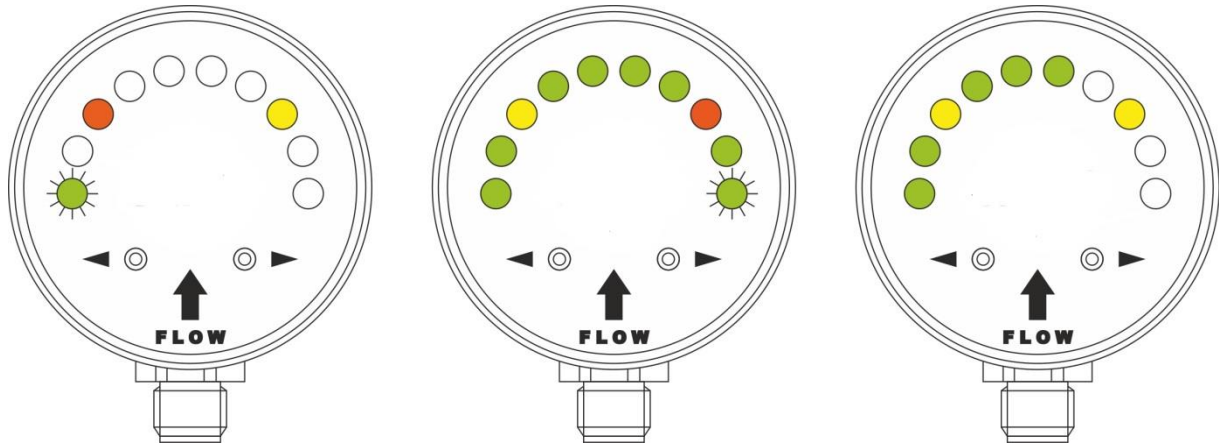

first LED flashing = the flow is below the monitor monitoring range

last LED flashing = the flow is above the monitoring range

the flow velocity is within the adjusted monitoring range

The number of green illuminated LEDs roughly indicates the flow rate within the given range.



If none of the LEDs is lit or flashing, the device is most likely disconnected from the supply voltage!!!

Basic parameter default setting

The flow monitor parameters are set by the manufacturer according to purchase order. The device is set to default parameters by the manufacturer (see the Table below). The operator may make alterations by means of two buttons on the panel of the device (page 14).

Factory settings for water

Minimum flow rate	<8cm/s (2% Qmax)	First LED flashing
-------------------	------------------	--------------------

Switching point	40cm/s (10% Qmax)	Red/amber LED
Maximum flow speed	>400cm/s (100% Qmax)	Last LED flashing

Note: The value of switching point in the table are only informative and depend on the fact if the flow rate increase or decrease with time, i.e. this switching point have a hysteresis, which is set by the manufacturer.

Tableview of LEDs according to the percentage of settings of maximal flow.

(Factory setting of speed is standardly Qmax = 4m/s)

LED-display	Flow velocity in % of setting setting Qmax
Flashing LED 1	below 2%
Lighting LED 1	2-5%
Lighting LED 2	5-10%
Lighting LED 3	10-15%
Lighting LED 4	15-20%
Lighting LED 5	20-25%
Lighting LED 6	25-35%
Lighting LED 7	35-47,5%
Lighting LED 8	47,5-62,5%
Lighting LED 9	62,5-80%
Lighting LED 10	80-100%
Flashing LED 10	above 100%

5. Adaptation and control

Switching point

Press down the button ◀ and hold until the green LEDs start flashing. After the button is released, the red LED indicating switching/circuit-opening point starts flashing. Using the ◀ ▶ buttons you can move this switching point to the positions of LED 2 to 9. After completion of the setting, wait until automatic storage operation is over and the meter goes to measuring mode.

The change in logic of NC/NO output

Press down simultaneously the ◀ ▶ buttons on the meter panel and hold unless green LEDs start flashing. After the buttons are released, the change of NC/NO contact is activated.

MINIMUM flow calibration in the monitor

In order to calibrate the MINIMUM flow, press down the ◀ button and hold it until the red LEDs start flashing. After releasing the button, the MINIMUM flow will be automatically registered and the sensor returns to measurement mode. MINIMUM calibration is completed by this action. Carry out this setting only if necessary (usually, after using with an oil medium, etc.), this default factory setting done for water.

MAXIMUM flow calibration in the monitor

In order to calibrate the MAXIMUM flow, press down the ▶ button and hold it until the red LEDs start flashing. After releasing the button, the MAXIMUM flow will be automatically registered and the sensor returns to measurement mode. MAXIMUM calibration is completed by this action. Carry out this setting only if necessary (usually, after using with an oil medium, etc.), this default factory setting done for water.

Restoring parameters to factory default values

Press down simultaneously the ◀ ▶ buttons on the meter panel and hold them until red LEDs start flashing (red LEDs flashing precedes green LEDs flashing, serving for changing the polarity of NC/NO contact). After releasing both buttons, RESET is applied and factory defaults are restored.

6. Technical data

Supply voltage	24V ±10% DC with polarity reversal protection
Input power	1.5/4VA
Electrical connection	connector M12 x 1-4 pin
Process connection	see accessories
Sensor version	compact
Indicator	10x tri-colour LED (flow velocity)
Contact rating	130mA/ 60V/ 500mW
Status contact	SSR semiconductor relay PNP/N PN
Current loop	4 ÷ 20 mA, active

Response time	1 ÷ 6sec for water (25°C)
Flow ranges	4 ÷ 400cm/s
Accuracy	± 2 ÷ ± 8cm/s
Hysteresis	2 ÷ 8cm/s
Control	2× flush-mounted button
Temperature of liquid	-10 ÷ +80°C
Ambient temperature	-20 ÷ +55°C
Material in contact with medium	stainless steel 1.4404, PTFE (according to the connection option)
Maximum pressure	100 bar
IP code	IP67
Ambient humidity	max. 90%
Dimensions (H x W x D):	
- compact:	91x74x60mm (in case of the longer version, the height is 151mm)
Weight	290g

7. Dimensions

Compact version

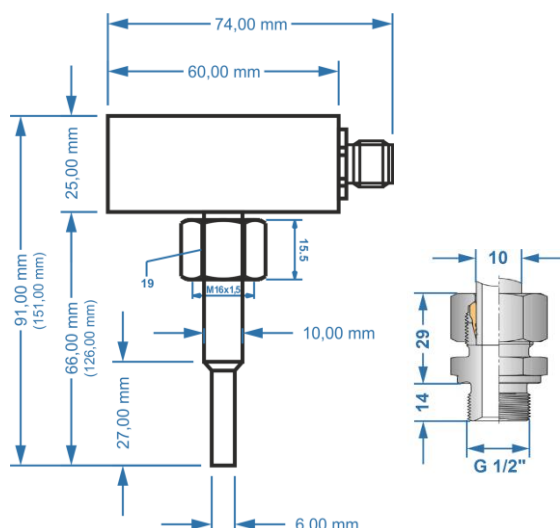

7.1 Accessories

In case when it is necessary to monitor the media flow in pipe with a smaller DN than DN 25 (or the flow velocity is below the sensor range at the pipe diameter given), it is possible to use an adapter block with a corresponding flow velocity and ensure correct operation and keep the installation conditions in this way.

Adapters are designed for short version of sensor 65mm with using direct socket with pipe thread G 1/2".

Individual designs:

FS adapter block DN20/G3/4"	1 ÷ 10 l/Min. (dimensions 150x50x40 mm)
FS adapter block DN15/G1/2"	0,5 ÷ 5 l/Min. (dimensions 150x50x30 mm)
FS adapter block DN10/G1/4"	0,2 ÷ 2 l/Min. (dimensions 150x50x30 mm)
FS adapter block DN4,7/G1/4"	50 ÷ 500 ml/Min. (dimensions 70x50x30 mm)
FS adapter block DN2,7/G1/4"	2 ÷ 100 ml/Min. (dimensions 70x50x30 mm)



8. Dismounting, Return, Cleaning, Disposal

8.1 Dismounting



Warnung

Residual media in dismantled instruments can result in a risk of personnel, the environment and equipment. Take sufficient precautionary measures.



Warnung

There is a risk of burns. Let the instrument cool down sufficiently before dismantling. During dismantling there is a risk of dangerously hot pressure media escaping.

Only disconnect the resistance thermometer once the system has been depressurized.

8.2 Return



Warnung

When returning the instrument, use the original packaging or a suitable package. To avoid damage, use for example antistatic

plastic film, shock-absorbent material, a marking as highly sensitive measuring instrument.

8.3 Cleaning



Before cleaning the instrument disconnect the electrical connection.

Clean the instrument with a moist cloth.

Electrical connections must not come into contact with moisture.

Wash or clean the dismantled instrument before returning it in order to protect personnel and the environment from exposure to residual media.

Residual media in dismantled instruments can result in a risk to persons, the environment and equipment. Take sufficient precautionary measures.

8.4 Disposal



Dispose instrument components and packaging materials in accordance with the respective waste treatment and disposal regulations of the region or country to which the sensor is supplied.